

正面図

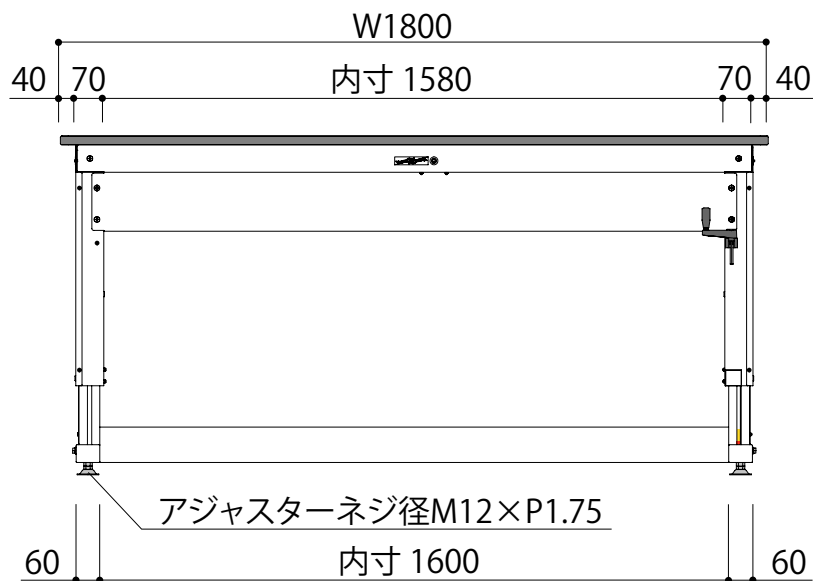

側面図

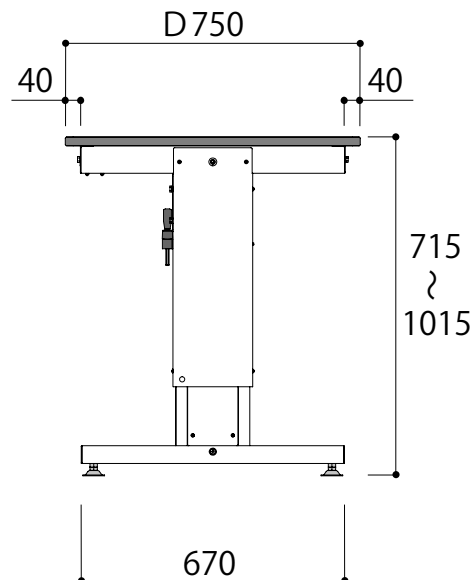

SSP-1875A-IW

W1800 × D750 × H715 ~ 1015