

正面図

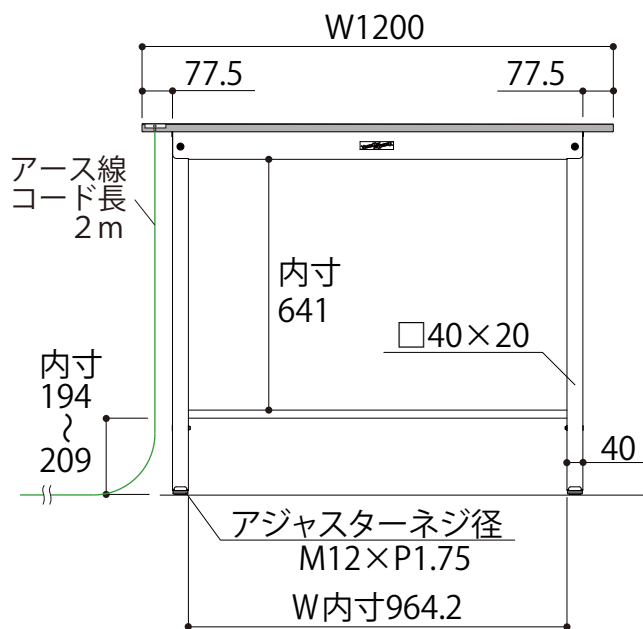

側面図

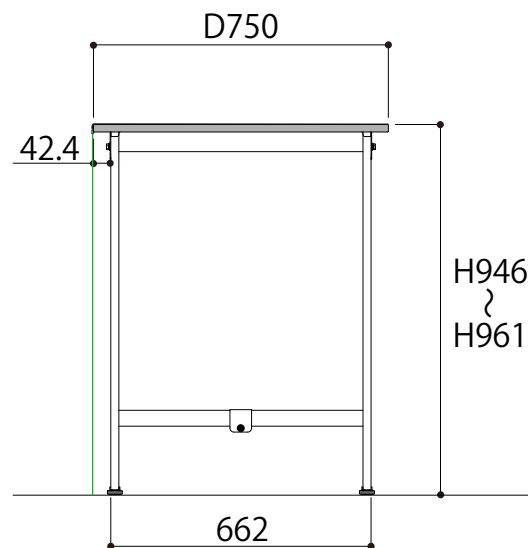

SUPEH-1275-WW
W1200 × D750 × H950