

正面図

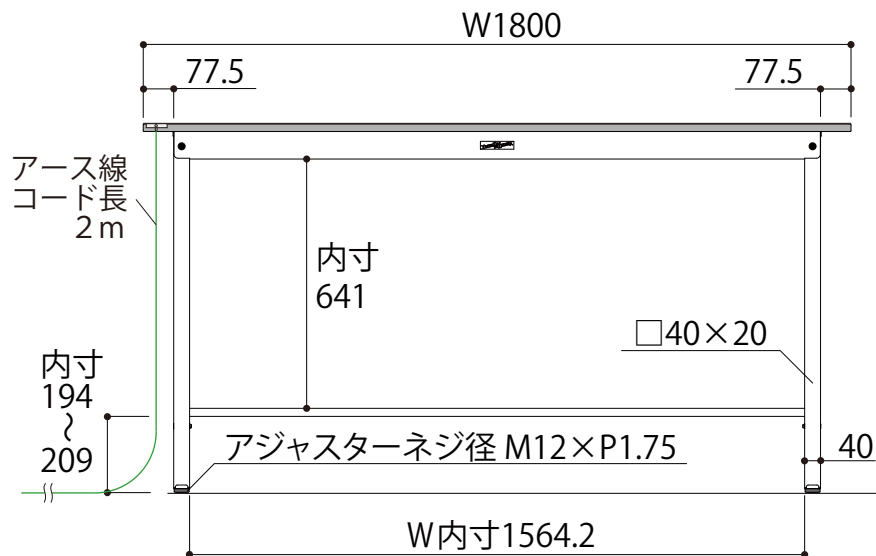

側面図

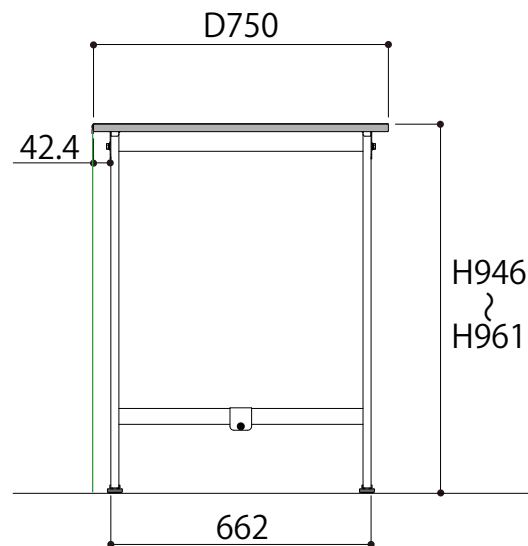

SUPEH-1875-WW
W1800 × D750 × H950