

正面図

側面図

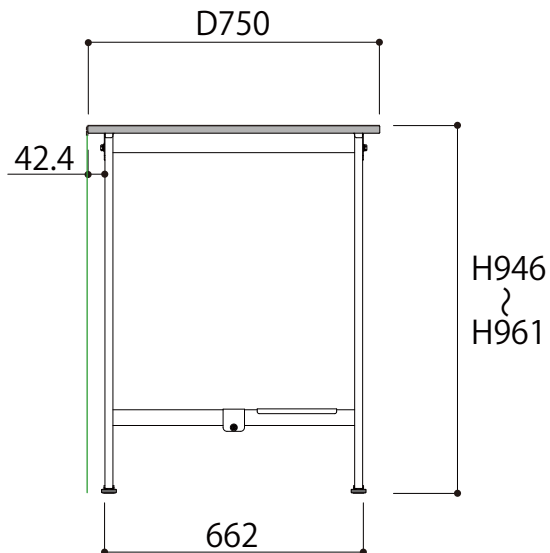
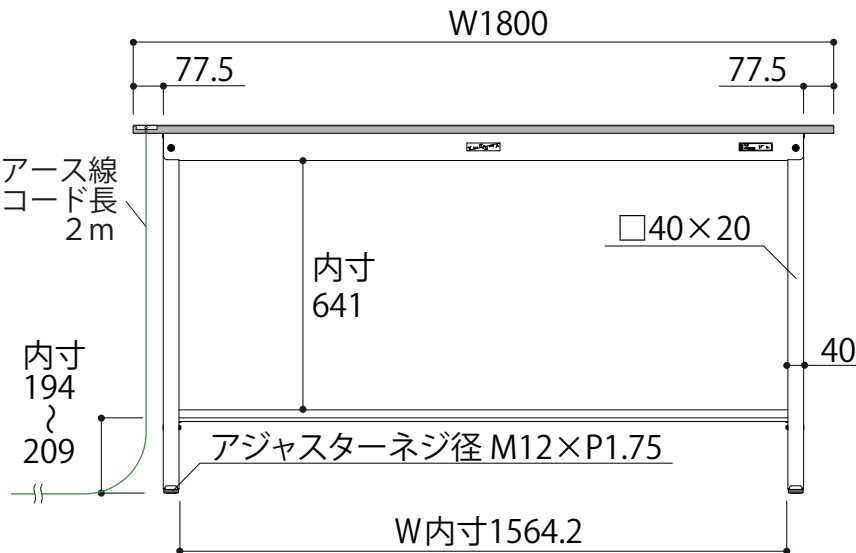

SUPEH-1875T-WW
W1800 × D750 × H950