

正面図

側面図

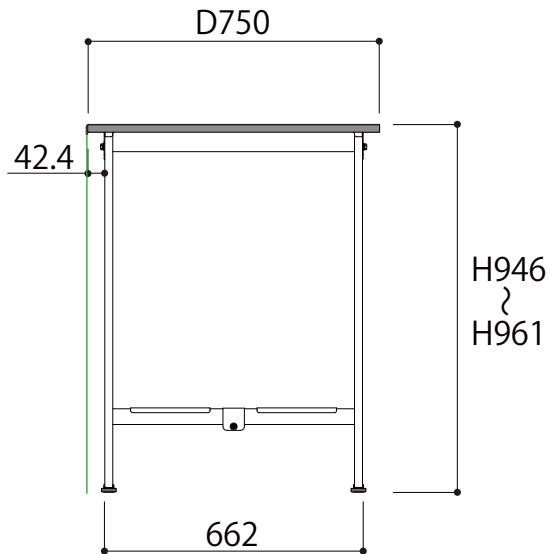
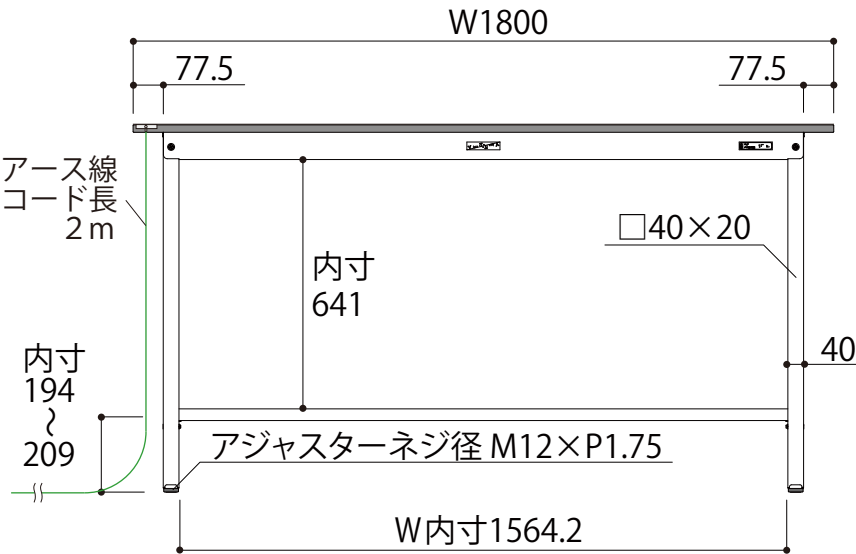

SUPEH-1875TT-WW  
W1800 × D750 × H950