

正面図

側面図

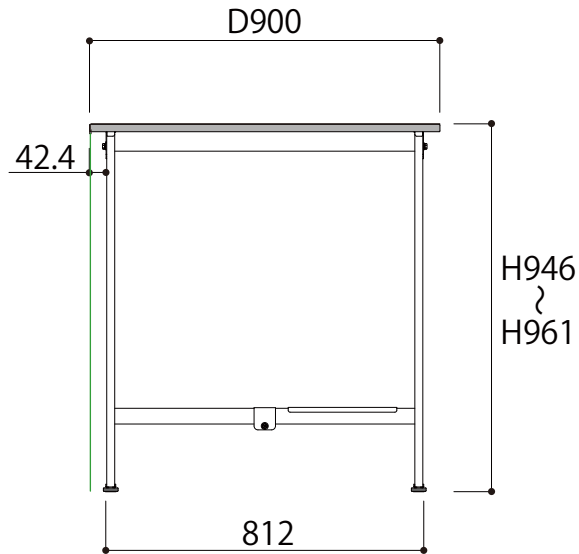
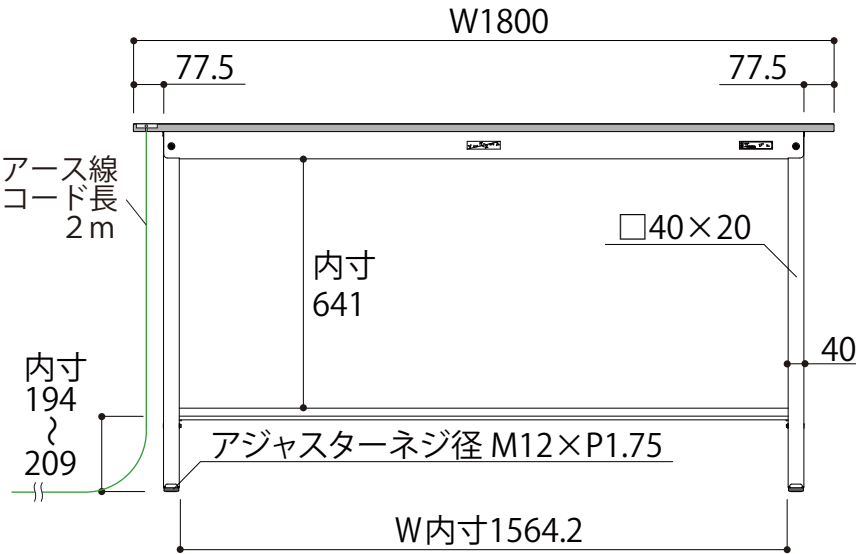

SUPEH-1890T-WW
W1800 × D900 × H950