

正面図

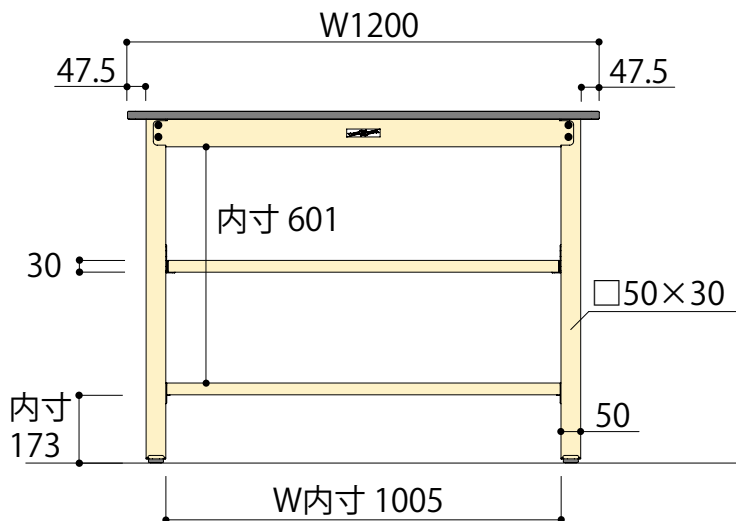

側面図

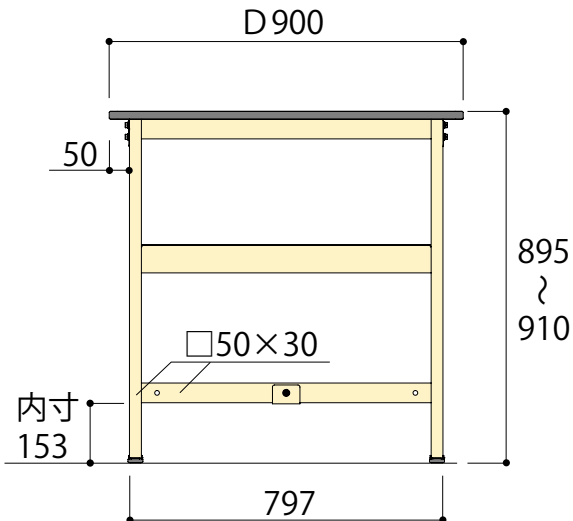

SWPH-1290S2-II

W1200 × D900 × H900